

MP-03 Push-to-Close Flush Latch

50mm · Plastic

Features

- Adjustable grip
- Round-hole installation
- Inside actuation when locked or unlocked

Accessories

- Keeper: M1-519-4
- Replacement mounting screw: MP-520-28-4
- Key 948 (pair): MF-97-948-41

Material

- Housing cover, cup and handle: Stainless steel 316 grade, electropolished
- Housing: PC/PBT blend, black or white

Product Performance

- Maximum working load: 270 N
- Operating temperature range: -18 °C to 60 °C
- Flammability rating: UL94-HB
- Maximum tightening torque on mounting screws (supplied): 1.7 N.m



Non-Locking

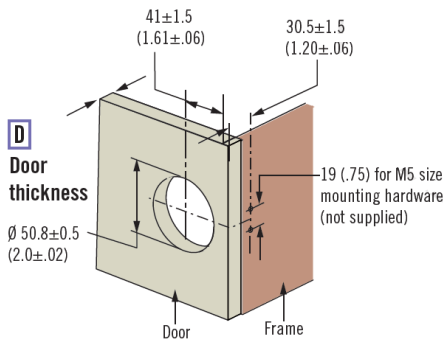
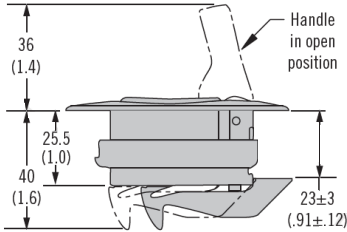
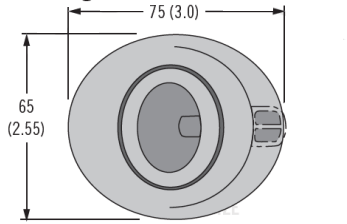

Locking

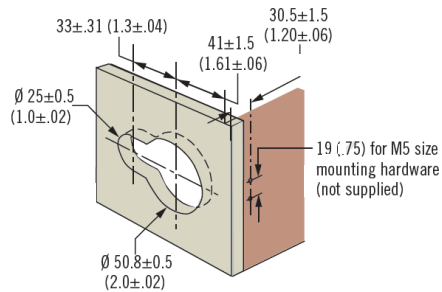
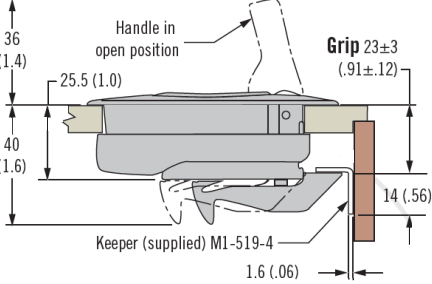
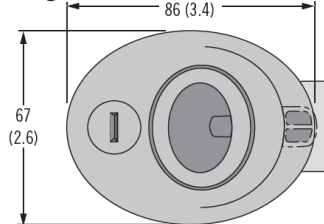

Installation

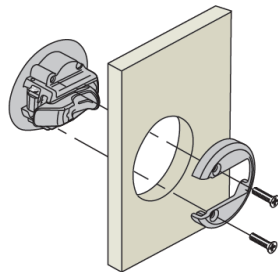

Grip Adjustment

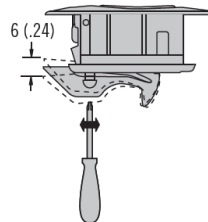

MP - 03 - 1 L D - F 0

L Lock style
0 Non-locking
1 Key-locking keyed alike 948 (2 keys supplied)

D Door thickness
0 10 - 16 (.39 - .63)
1 16 - 22 (.63 - .87)

F Finish
00 316 Stainless cover over black housing
55 Black housing
77 White housing

southco®

We are proud to be Southco's
authorized distributor of over 20 years